

REVISION HISTORY			
REV	DESCRIPTION	DATE	APPROVED

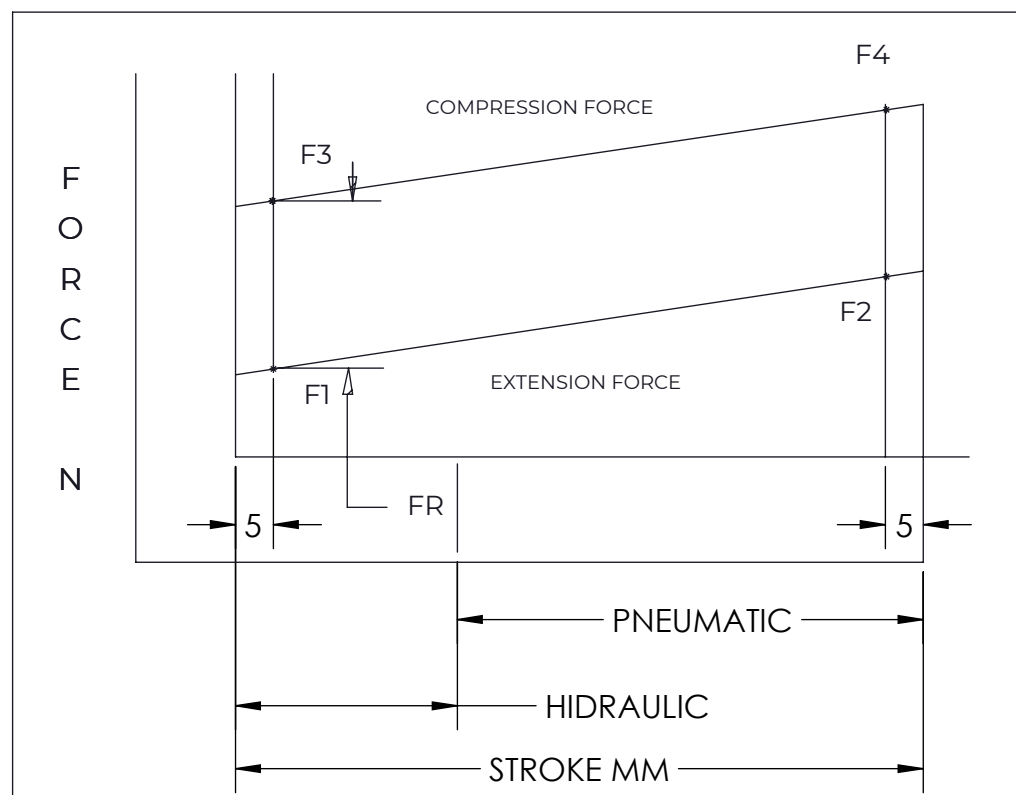
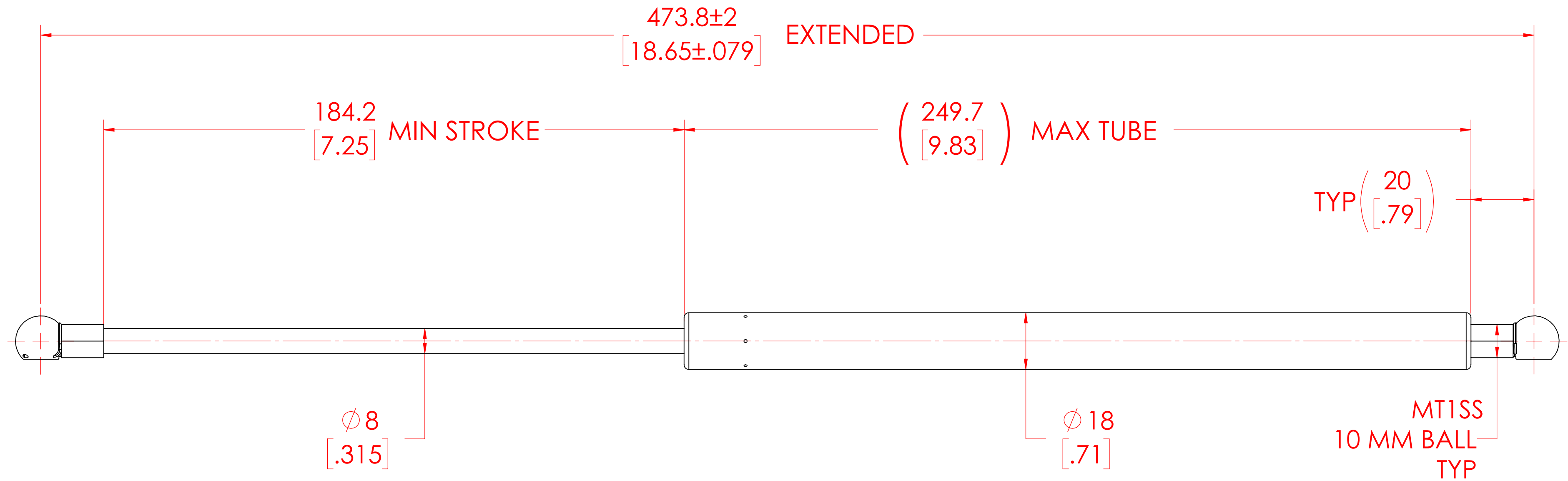

FORCES (STATICALLY MEASURED)	
F1	F2
90 LBS (400 N) +25N -10N	-

NOTES:

- 1) MATERIAL: CYLINDER - STAINLESS STEEL 316, NO PAINT / ROD - STAINLESS STEEL 316.
- 2) OPERATING TEMPERATURE: -40°C TO +80°C.
- 3) STANDARD PART IDENTIFICATION TO INCLUDE PART NUMBER, DATE CODE AND WARNING MESSAGE.
- 4) GAS SPRING IS SUGGESTED TO BE MOUNTED SHAFT DOWN (ROD DOWN) FOR MAXIMUM PERFORMANCE.
- 5) END FITTINGS TO BE ORIENTED AS SHOWN ±5°.
- 6) GAS SPRINGS WILL BE SEALED IN CLEAR PLASTIC BAGS TO AVOID DAMAGE, DUST, OR OTHER FOREIGN OBJECTS.
- 7) GAS SPRING TO BE ASSEMBLED WITH END FITTINGS COMPLETELY FASTENED.
- 8) GREASE TO BE INCLUDED INSIDE THE BALL SOCKET OF THE END FITTINGS.

<h1>NORMONT</h1> <p>THIS DOCUMENT AND ITS CONTENTS ARE THE PROPERTY OF NORMONT</p> <p>THIS DOCUMENT CONTAINS CONFIDENTIAL PROPRIETARY INFORMATION. THE REPRODUCTION, DISTRIBUTION, UTILISATION OR THE COMMUNICATION OF THIS DOCUMENT OR ANY PART THEREOF, WITHOUT EXPRESS AUTHORISATION IS STRICTLY FORBIDDEN.</p>	NAME	DATE	
	DRAWN	DMA	05/06/2024
	CHECKED		
	PART No.	NSSG1850M90MTISS	REV
TITLE	STAINLESS STEEL GAS SPRING		
TOLERANCES	THIRD ANGLE PROJECTION	SCALE	
XX ± 0.060		NTS	
X.XX ± 0.030		SIZE	
X.XXX ± 0.010		C	
ANGLES ± 1°			
HOLES ± 0.005	SHEET 1 OF 1		
REMOVE ALL BURRS AND BREAK ALL SHARP EDGES	ALL DIMENSIONS ARE DUAL UNLESS OTHERWISE SPECIFIED		