

REVISION HISTORY			
REV	DESCRIPTION	DATE	APPROVED

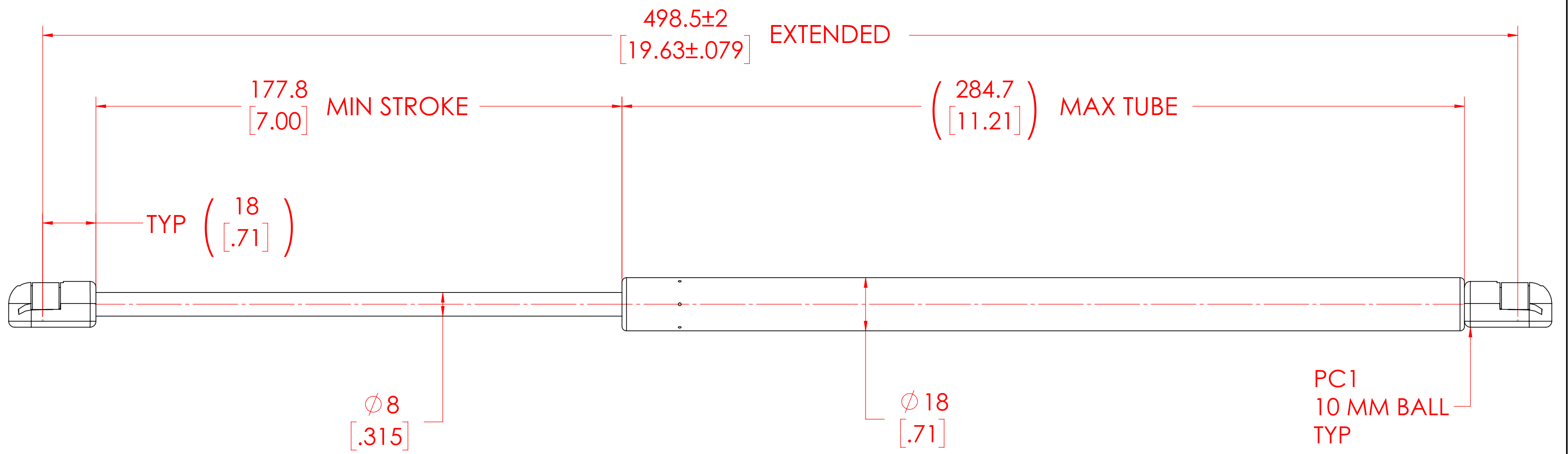

FORCES (STATICALLY MEASURED)	
F1	F2
60 LBS (267 N) +25N -10N	-

- NOTES:**
- 1) MATERIAL: CYLINDER - STAINLESS STEEL 316, NO PAINT / ROD - STAINLESS STEEL 316.
  - 2) OPERATING TEMPERATURE: -40°C TO +80°C.
  - 3) STANDARD PART IDENTIFICATION TO INCLUDE PART NUMBER, DATE CODE AND WARNING MESSAGE.
  - 4) GAS SPRING IS SUGGESTED TO BE MOUNTED SHAFT DOWN (ROD DOWN) FOR MAXIMUM PERFORMANCE.
  - 5) END FITTINGS TO BE ORIENTED AS SHOWN ±5°.
  - 6) GAS SPRINGS WILL BE SEALED IN CLEAR PLASTIC BAGS TO AVOID DAMAGE, DUST, OR OTHER FOREIGN OBJECTS.
  - 7) GAS SPRING TO BE ASSEMBLED WITH END FITTINGS COMPLETELY FASTENED.
  - 8) GREASE TO BE INCLUDED INSIDE THE BALL SOCKET OF THE END FITTINGS.

<b>NORMONT</b>	NAME	DATE	
	DRAWN	DMA	05/06/2024
	CHECKED		
	PART No.	NSSG1963M60PC1	REV
THIS DOCUMENT AND ITS CONTENTS ARE THE PROPERTY OF NORMONT THIS DOCUMENT CONTAINS CONFIDENTIAL PROPRIETARY INFORMATION. THE REPRODUCTION, DISTRIBUTION, UTILISATION OR THE COMMUNICATION OF THIS DOCUMENT OR ANY PART THEREOF, WITHOUT EXPRESS AUTHORISATION IS STRICTLY FORBIDDEN.	TITLE		STAINLES STEEL GAS SPRING
	TOLERANCES		THIRD ANGLE PROJECTION
	XX	± 0.060	
	X.XX	± 0.030	
	X.XXX	± 0.010	
ANGLES	± 1°	SHEET 1 OF 1	
HOLES	± 0.005		
REMOVE ALL BURRS AND BREAK ALL SHARP EDGES	ALL DIMENSIONS ARE <b>DUAL</b> UNLESS OTHERWISE SPECIFIED		SCALE <b>NTS</b> SIZE <b>C</b>